

Parts Breakdown

Model CE-CN-G15TPF 43016

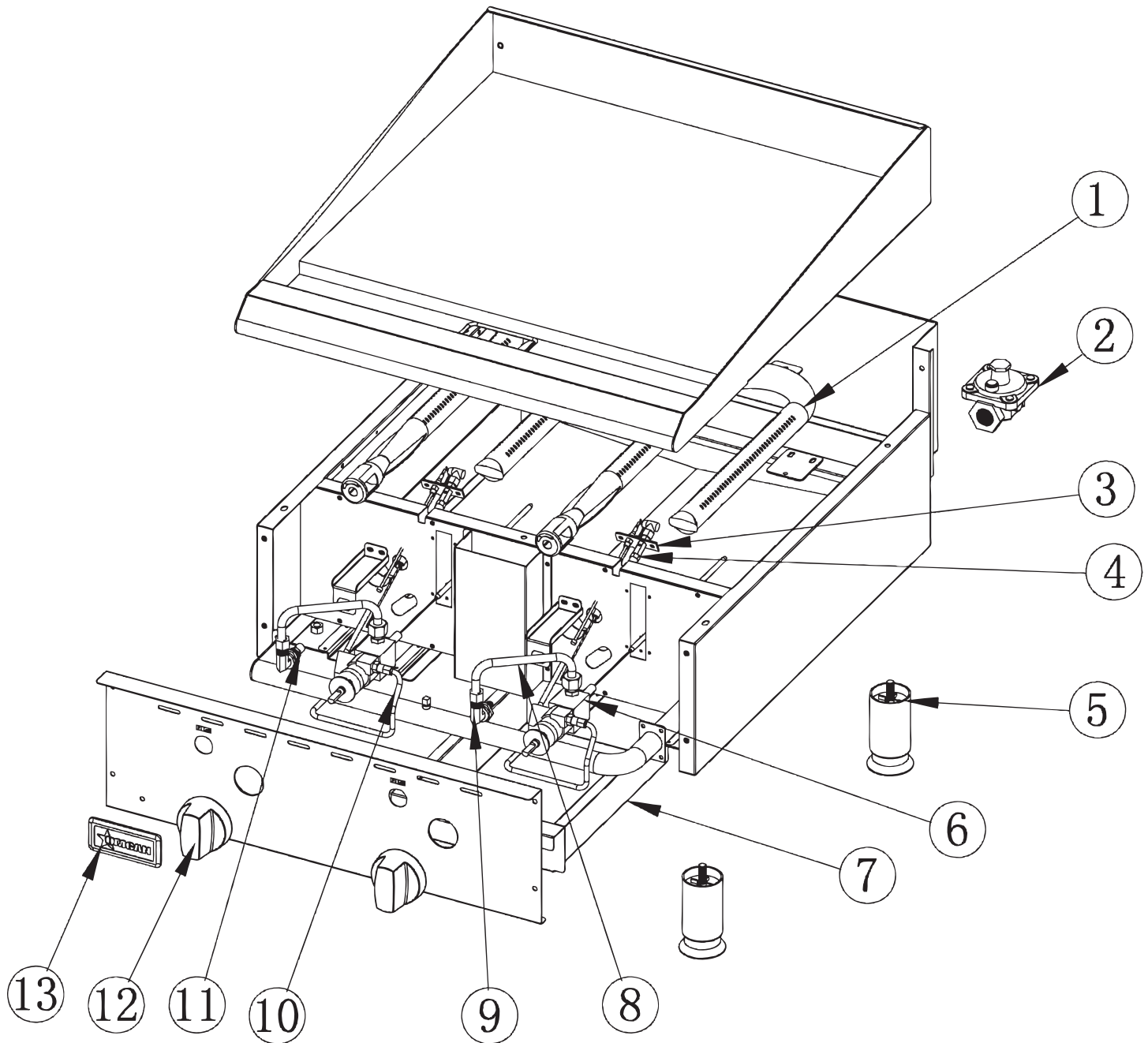



Parts Breakdown

Model CE-CN-G15TPF 43016

Item No.	Description	Position	Item No.	Description	Position	Item No.	Description	Position
73092	Burner for 43016	1	72411	Thermostat Valve for 43016	6	72416	Orifice 41 # NAT for 43016	11
72407	Regulator for 43016	2	72412	Tray for 43016	7	43315	Red Dial for Thermostat Control for 43016	12
72408	Flame Device System (Exclude Injector) for 43016	3	72413	Main Pipe Assy. for 43016	8	43313	Name Badge for Omcan for 43016	13
72409	ODS Injector-0.45 NAT for 43016	4	63534	Orifice Connection (Front) for 43016	9	43305	Conversion Kits for 43016	14
72410	Foot for 43016	5	72415	Pilot Pipe Assy. for 43016	10			